

Revision History

REV.	Description	Date	APP'D
C	Fix image cut off on side view	July/5/2023	ECN 2328-08 jh

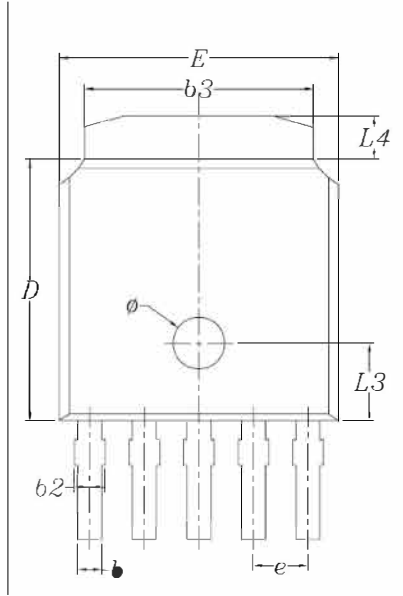

TOP VIEW

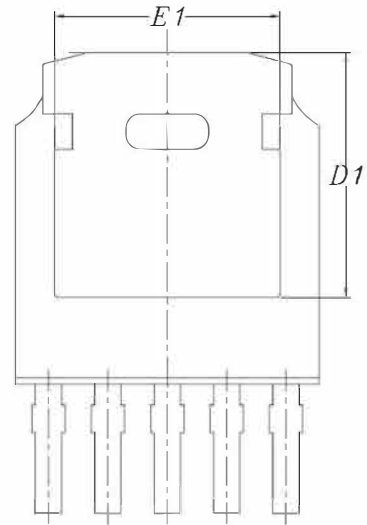

BOTTOM VIEW

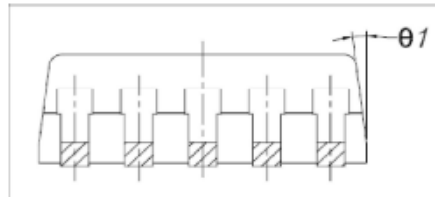

SIDE VIEW - 1

SYMBOLS	DIMENSIONS IN INCH		DIMENSIONS IN MILLIMETER	
	MIN.	MAX.	MIN.	MAX.
A	0.086	0.094	2.184	2.387
A1	0.000	0.005	0.00	0.127
b	0.020	0.028	0.508	0.711
b1	0.020	0.026	0.508	0.660
b2	0.024	0.031	0.610	0.787
b3	0.204	0.215	5.184	5.461
c	0.018	0.024	0.460	0.610
c1	0.016	0.022	0.406	0.559
c2	0.018	0.024	0.460	0.610
D	0.236	0.245	6.000	6.223
D1	0.198	/	5.050	/
E	0.250	0.265	6.350	6.731
E1	0.170	/	4.318	/
e	0.046	0.053	1.170	1.370
H	0.374	0.405	9.500	10.300
L	0.055	0.070	1.397	1.778
L1	0.094	0.118	2.400	3.000
L2	0.020 REF		0.508 REF	
L3	0.063	0.078	1.600	2.000
L4	0.035	0.050	0.889	1.270
$\theta$	0°	10°	0°	10°
$\theta 1$	0°	15°	0°	15°
$\emptyset$	0.041	0.053	1.05	1.35

TERMINAL DETAILS

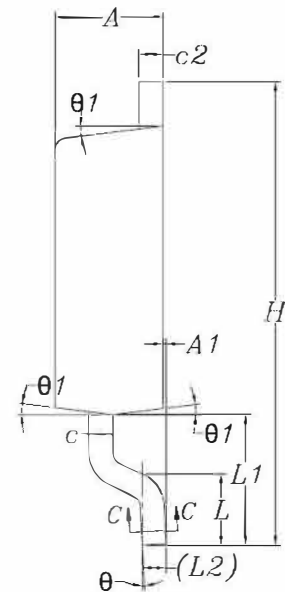

SIDE VIEW - 2

- ALL DIMENSIONS ARE IN MILLIMETERS, ANGLES ARE IN DEGREES.
- DIMENSIONS AND TOLERANCE PER JEDEC TO-252.

	<b>MAXLINEAR CORPORATION</b>	
	5LD TO252 Package Outline Drawing	
Packaging Approval:	Drawing No.: POD-00000165	
By: O. Rulloda Date: July.5.2023	Revision: C	Sheet 1 OF 2

Revision History			
REV.	Description	Date	APP'D
C	Initial release for XRP6272 part	July/5/2023	ECN 2328-08 jh

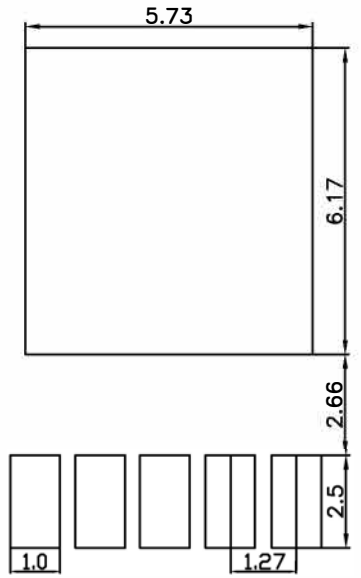

**TYPICAL RECOMMENDED LAND PATTERN**

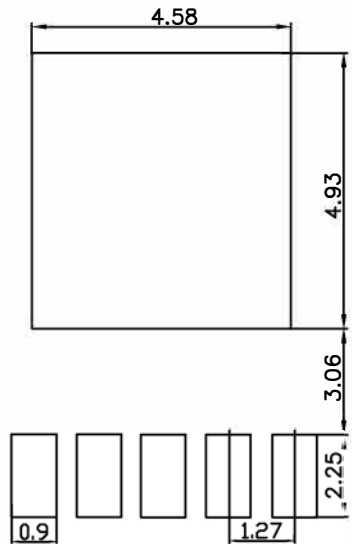

**TYPICAL RECOMMENDED STENCIL**

	<b>MAXLINEAR CORPORATION</b>	
	5LD TO252 Package Outline Drawing	
Packaging Approval:	Drawing No.: POD-00000165	Sheet 2 OF 2
By: O. Rulloda    Date: July. 5.2023	Revision: C	