

Revision History

REV.	Description	Date	APP'D
A	DRAWING ORIGATION	MAY/19/2016	ECN 1621-04 JH
B	CORRECT TYPO AND CHANGE FORMAT TO MAXLINEAR	NOV/08/2017	ECN 1746-11 jh

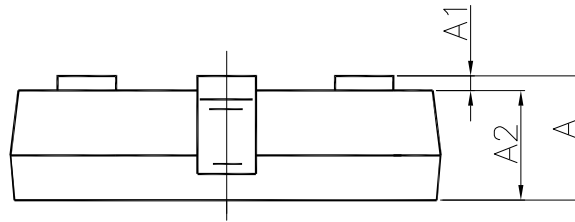
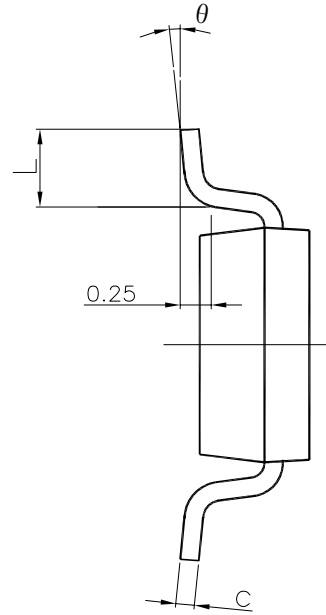
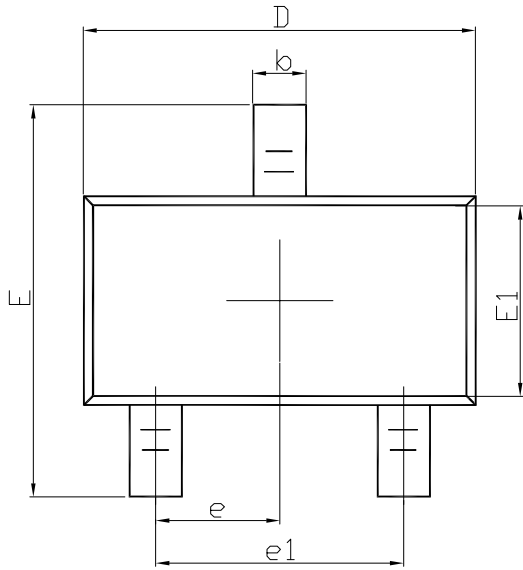

DIM SYMBOL	MIN	NOM	MAX
A	-	NA	0.90
A1	0.000	0.050	0.100
A2	0.700	0.750	0.800
b	0.350	0.425	0.500
c	0.080	1.140	0.200
D	2.820	2.920	3.020
E	2.650	2.800	2.950
E1	1.600	1.650	1.700
e	0.950(BSC)		
e1	1.900(BSC)		
L	0.300	0.450	0.600
θ	0	4	8

TERMINAL DETAILS

- ALL DIMENSIONS ARE IN MILLIMETERS, ANGLES ARE IN DEGREES.
- DIMENSIONS AND TOLERANCE PER JEDEC MO-193.

	MAXLINEAR CORPORATION	
	3LD TSOT 23 Package Outline Drawing	
Packaging Approval:	Drawing No.: POD-00000073	Sheet 1 OF 2
By: YG Eom Date: NOV.08.2017	Revision: B	

Revision History			
REV.	Description	Date	APP'D
A	DRAWING ORIGATION	MAY/19/2016	ECN 1621-04 JH
B	CORRECT TYPO AND CHANGE FORMAT TO MAXLINEAR	NOV/08/2017	ECN 1746-11 jh

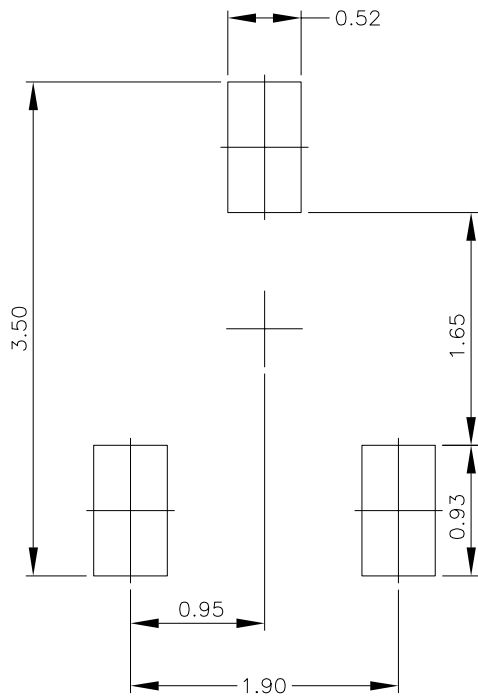

TYPICAL RECOMMENDED LAND PATTERN

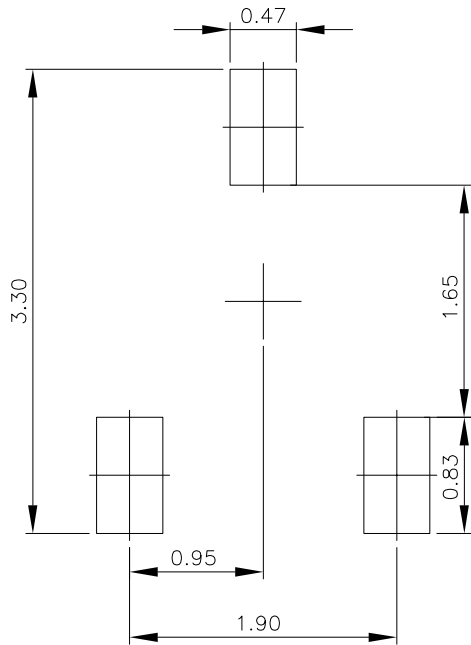

TYPICAL RECOMMENDED STENCIL

		MAXLINEAR CORPORATION	
		3LD TSOT 23 QFN Package Outline Drawing	
Packaging Approval:		Drawing No.: POD-00000073	Sheet 2 OF 2
By: YG Eom	Date: NOV.09.2017	Revision: B	