

REVISION HISTORY			
REV.	DISCRIPTION	DATE	APP'D
A	DRAWING ORIGINATION	07/14/10	PC

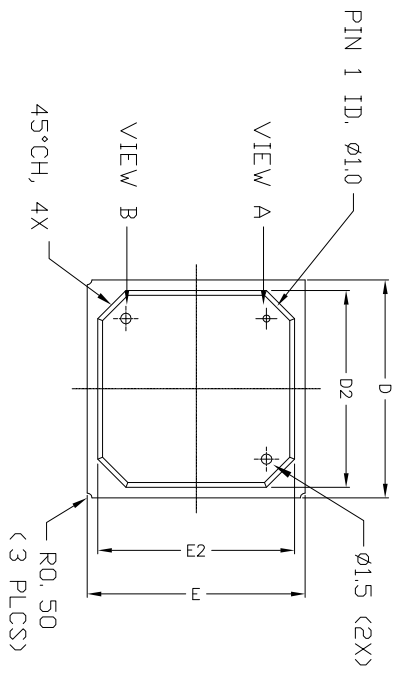

TOP VIEW

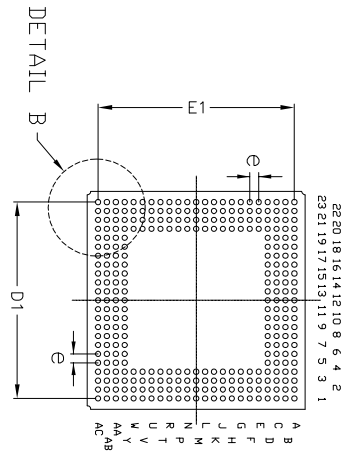

BOTTOM VIEW

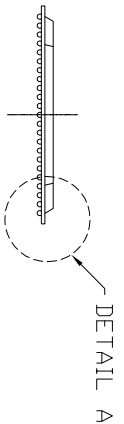

SIDE VIEW

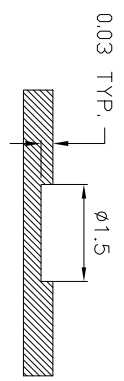

VIEW B

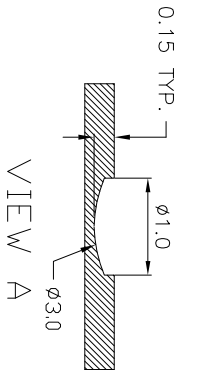

VIEW A

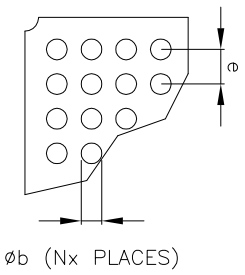

DETAIL B

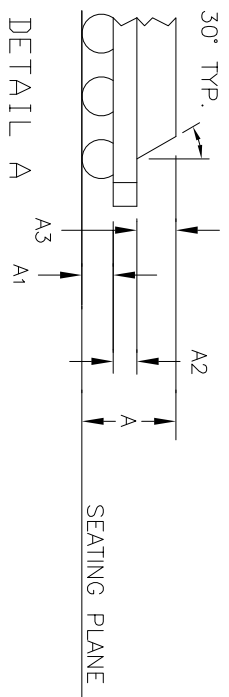

DETAIL A

SYMBOLS	DIMENSIONS IN MM (Control Unit)			DIMENSIONS IN INCH (Reference Unit)		
	MIN	NOM	MAX	MIN	NOM	MAX
A	2.17	2.33	2.49	0.085	0.092	0.098
A1	0.50	0.60	0.70	0.020	0.024	0.028
A2	0.52	0.56	0.60	0.020	0.022	0.024
A3	1.15	1.17	1.19	0.045	0.046	0.047
D	30.80	31.00	31.20	1.213	1.220	1.228
D1	27.94 BSC			1.100 BSC		
D2	27.90	28.00	28.10	1.098	1.102	1.106
E	30.80	31.00	31.20	1.213	1.220	1.228
E1	27.94 BSC			1.100 BSC		
E2	27.90	28.00	28.10	1.098	1.102	1.106
b	0.60	0.75	0.90	0.024	0.030	0.035
e	1.27 BSC			0.050 BSC		
M	23			23		
N	304			304		

NOTES: "W" REPRESENTS THE SOLDER BALL MATRIX SIZE.

		EXAR CORPORATION	
Packaging Approval:		Drawing No: 385-BALL 31X31mm PBGA	
By: PC	Date: 07/14/10	Revision: A	Sheet: 1 OF 1